

Africa &
China

18 Musical
Instrument

COLORING & Sheets

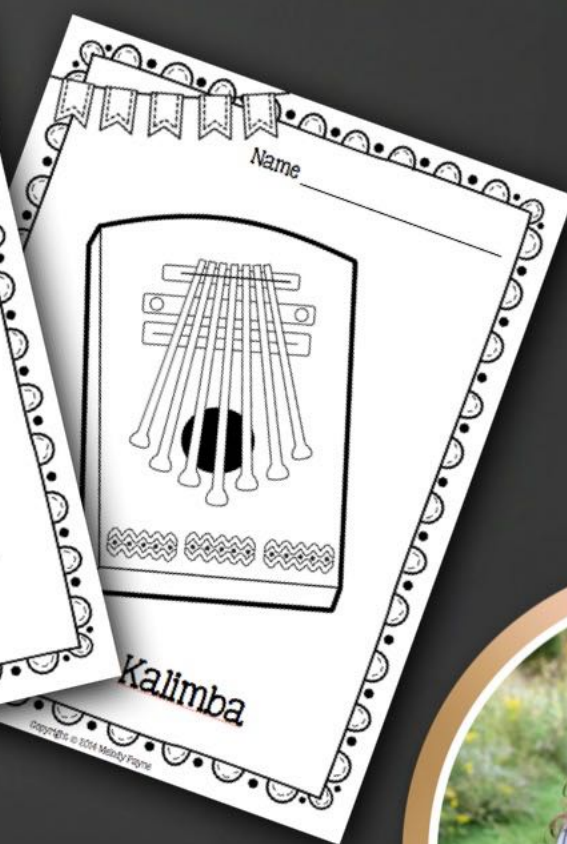
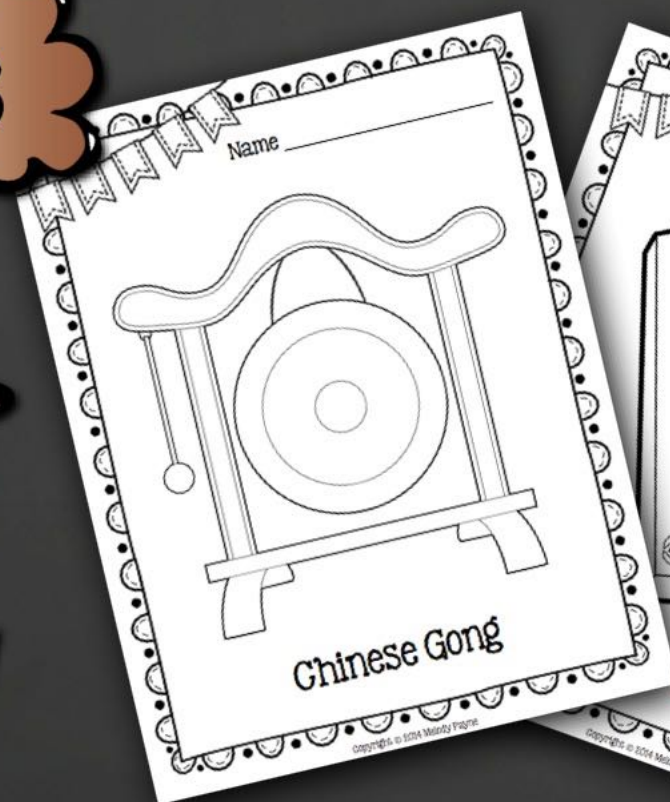

MELODY PAYNE
MUSIC FOR A LIFETIME

••• TERMS OF USE •••



Thank you for your purchase! By purchasing this resource, you agree that the contents are the property of Melody Payne with all rights reserved, and licensed to you only for classroom/personal use as a SINGLE USER/LICENSEE. I retain the copyright, and reserve all rights to this product. Your purchase of this product indicates your agreement to the Terms of Use. Failure to comply is a copyright infringement and a violation of the Digital Millennium Copyright Act (DMCA). Thank you for abiding by codes of professional ethics while using this product.

THE ORIGINAL PURCHASER MAY:

- Save this file to your personal home computer or personal school computer
- Reproduce the pages in limited quantities for classroom use only
- Purchase additional licenses at a discounted price from my store if you wish to share this resource with colleagues
- Reference (WITHOUT DISTRIBUTING) this product in blog posts, at seminars, professional development workshops, or other such venues PROVIDED there is both credit given to myself as the author, and a link to my TpT store is included in your post/presentation

THE ORIGINAL PURCHASER MAY NOT:

- Duplicate for an entire school or an entire school system without written permission from Melody Payne
- Claim the digital or hard copy of this file, in whole or in part, as your own
- Create derivative works from the file, digital or hard copy
- Give away, sell, or distribute the file, digital or hard copy, to any individual
- Copy any part of this product and place it on the Internet in any form. These items can be picked up in a Google search and then shared worldwide for free.
- Benefit from this product financially, digital or hard copy, in part or in whole

HOW TO EARN TPT CREDITS:

After you and your students have enjoyed using this product, please leave feedback on the product by visiting your "My Purchases" on TpT. [Click here to learn how to earn credit towards your next TpT purchase.](#)

CONTACT ME:

If you have questions about a product, or if you spot an error that needs to be corrected, please contact me at <https://melodypayne.com/contact/>

LET'S CONNECT!



TpT Store



Blog



Newsletter



Pinterest



Instagram



Facebook

Thanks for the Graphics & Fonts!

Kelly B. at www.teacherspayteachers.com/Store/Kelly-Benefield

Fancy Dog Studio at www.FancyDogStudio.com

I'm Lovin' Lit at www.teacherspayteachers.com/Store/Lovin-Lit

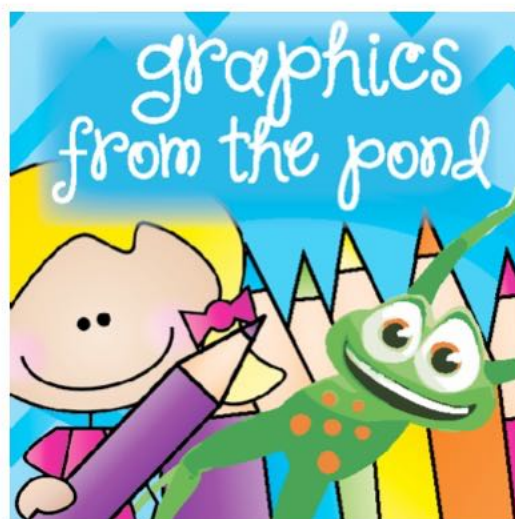

Name _____

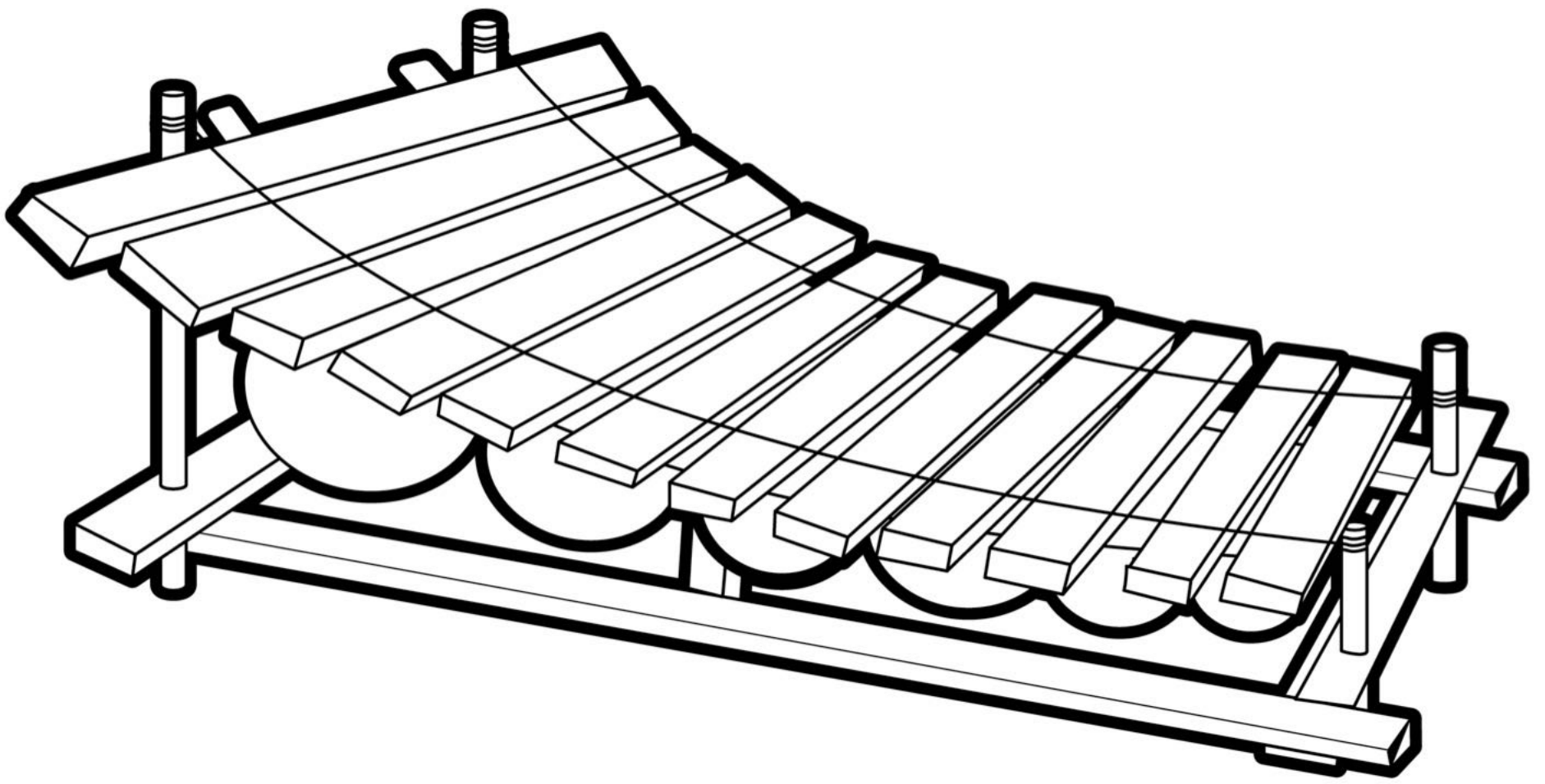

African Balafon

Name _____

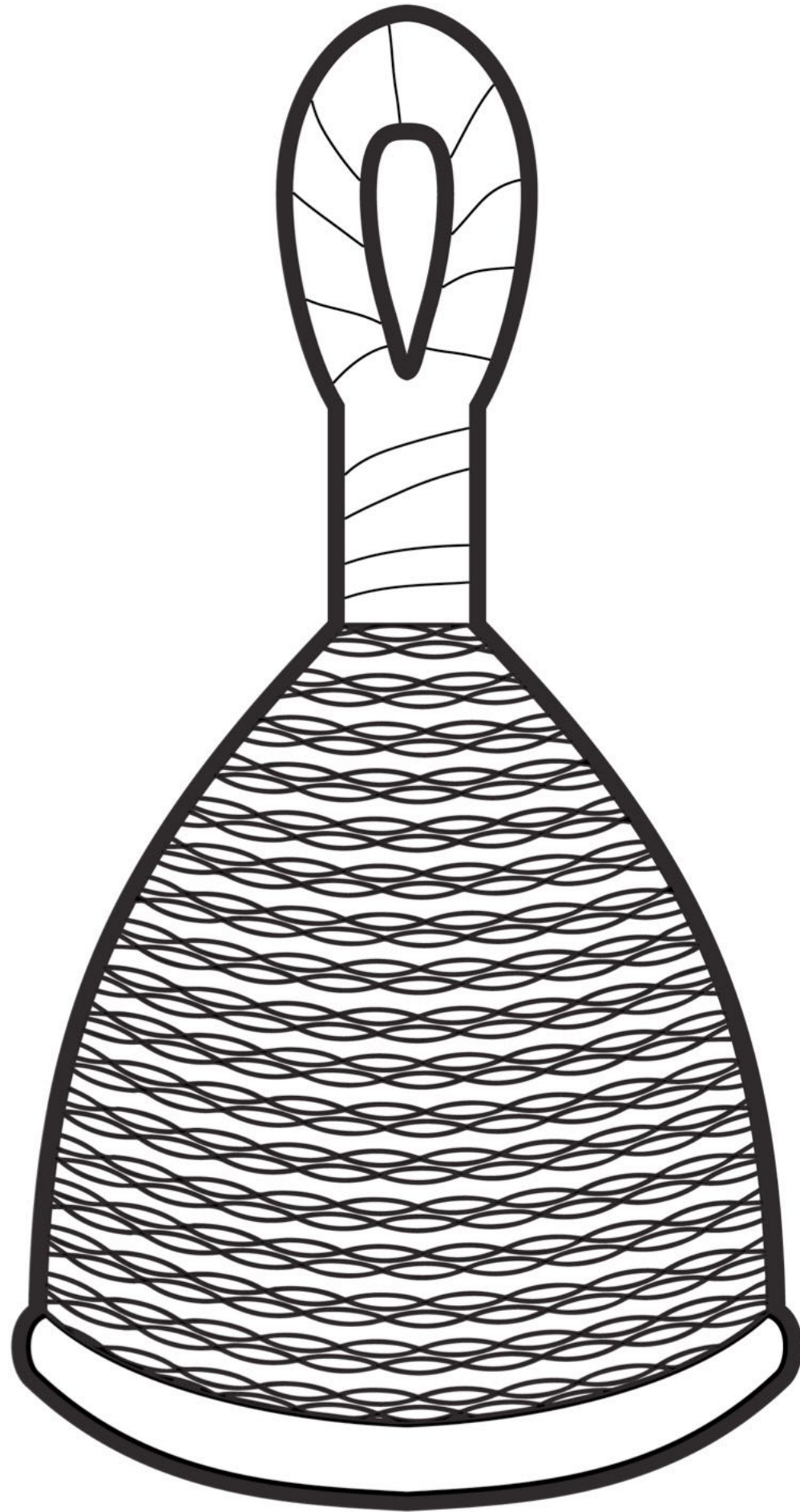

African Gaxixi

Name _____

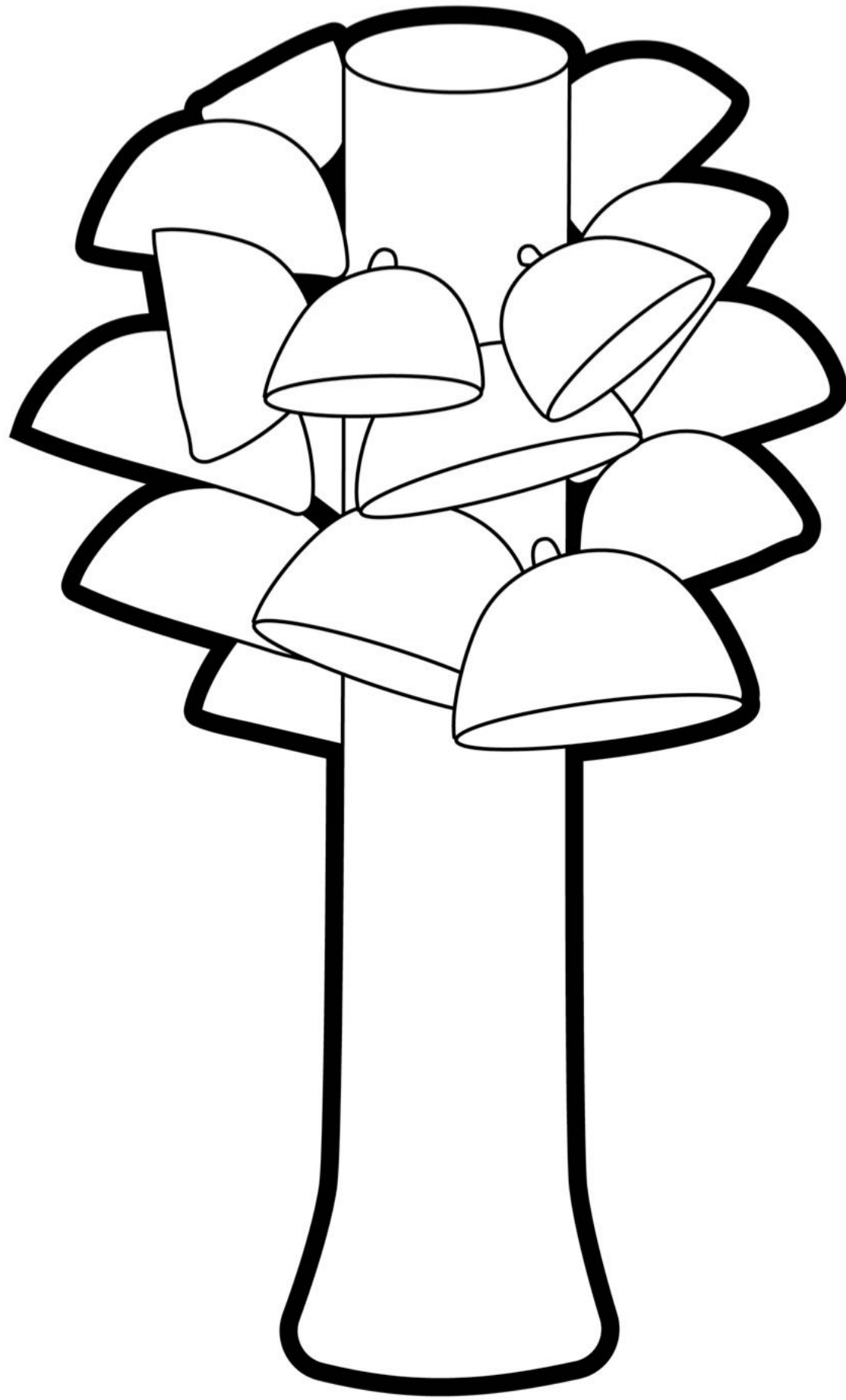

African Juju Shaker

Name _____

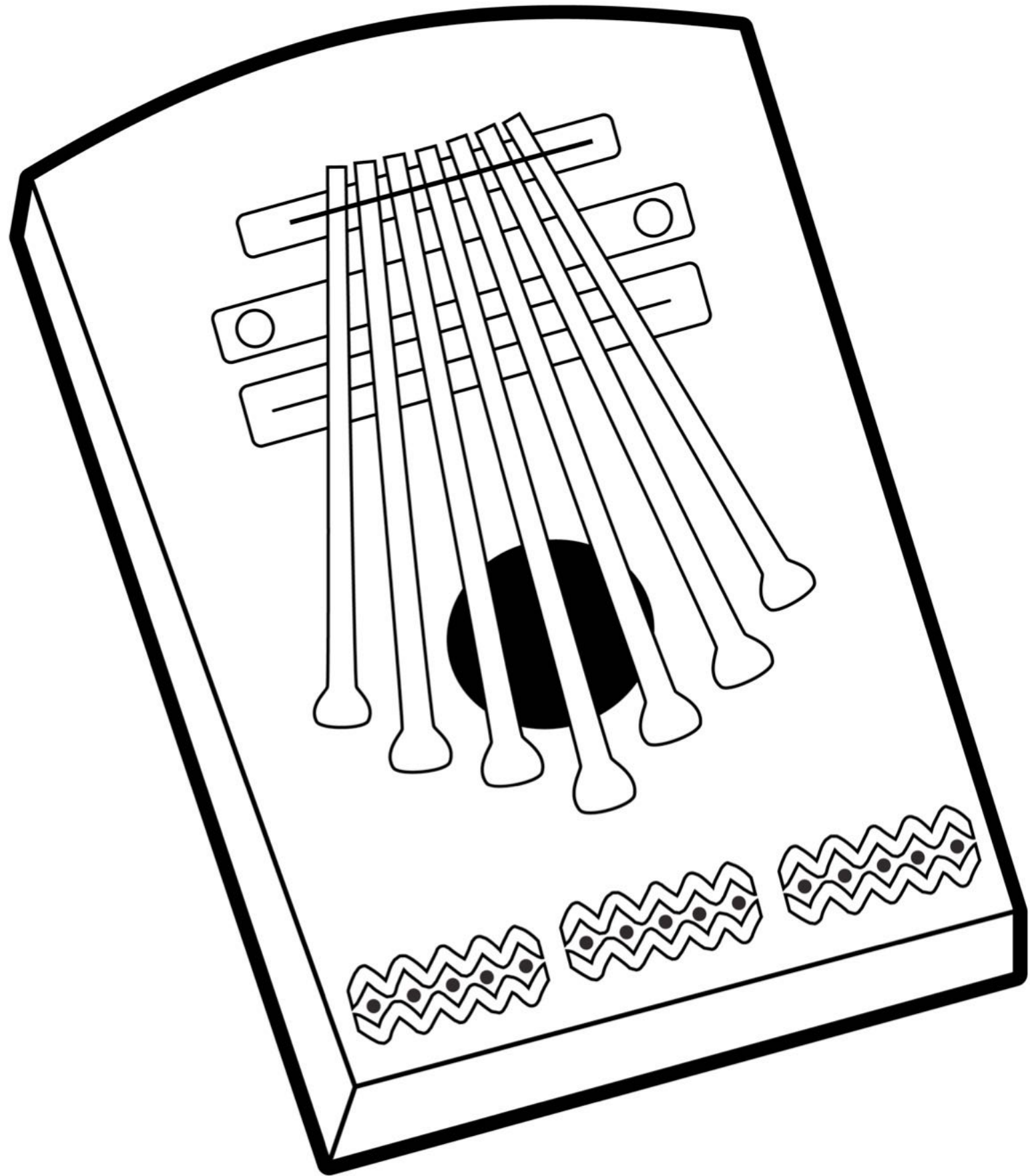

African Kalimba

Name _____

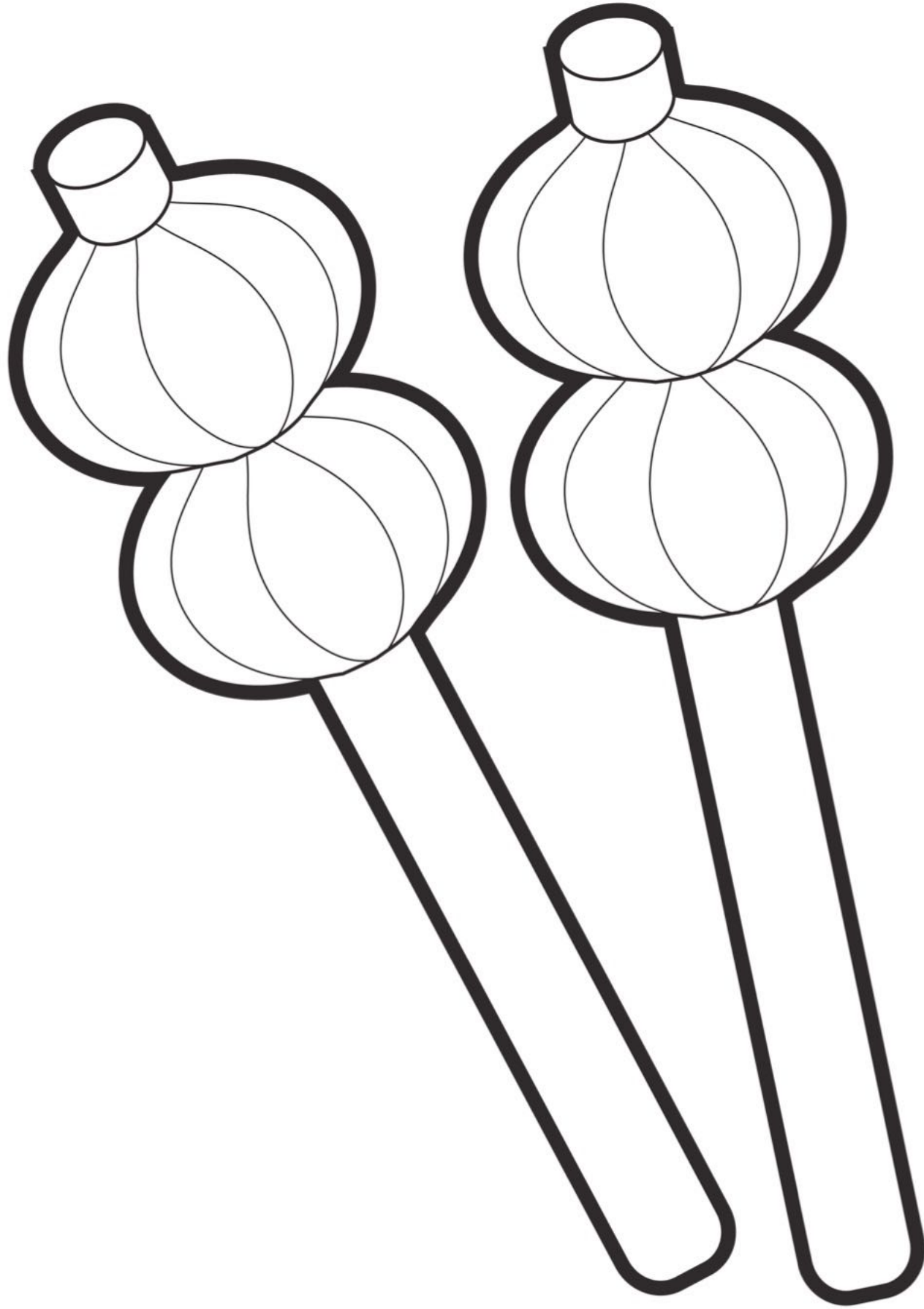

African Seed Shakers

Name _____

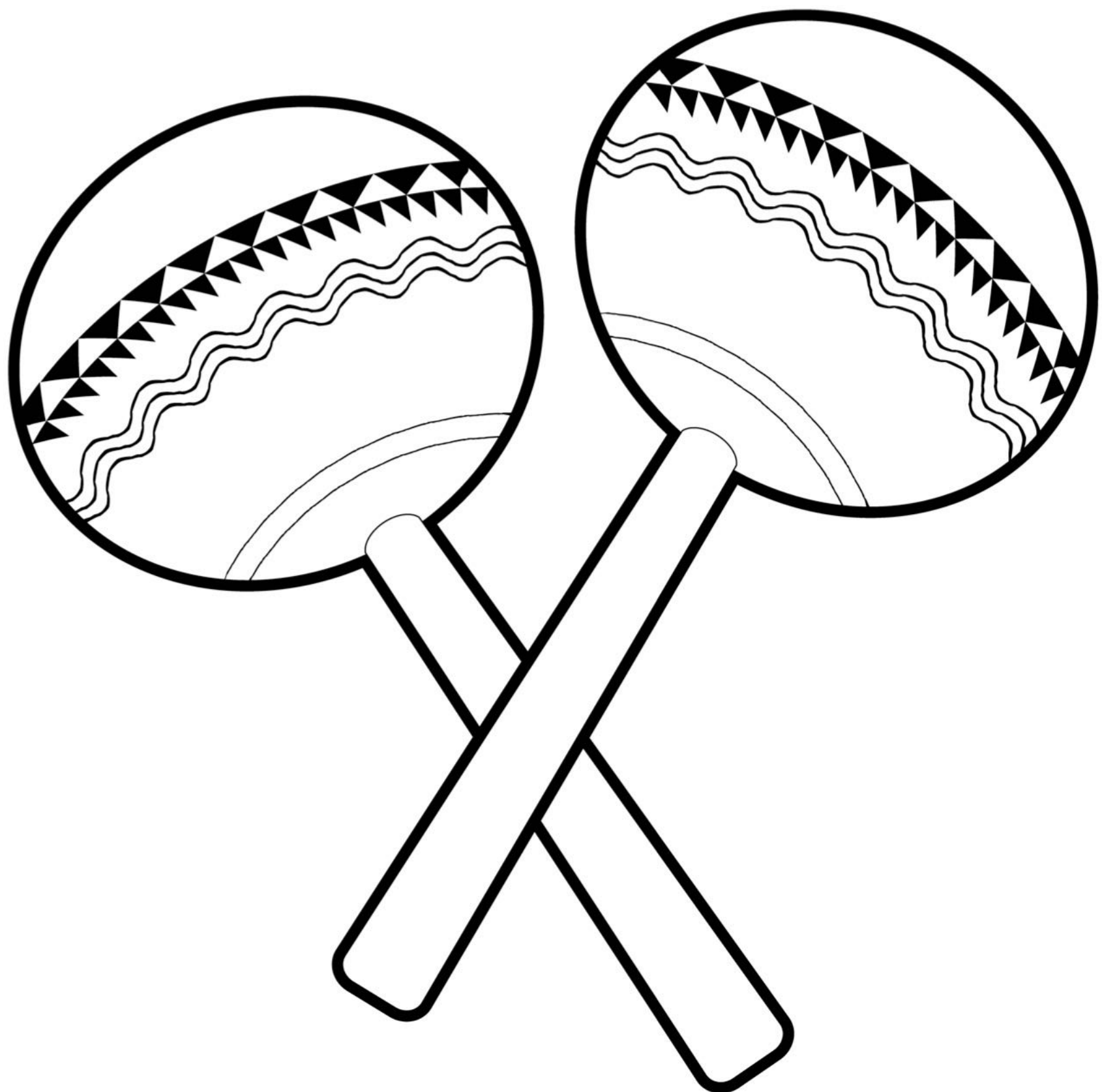

African Shakers

Name _____

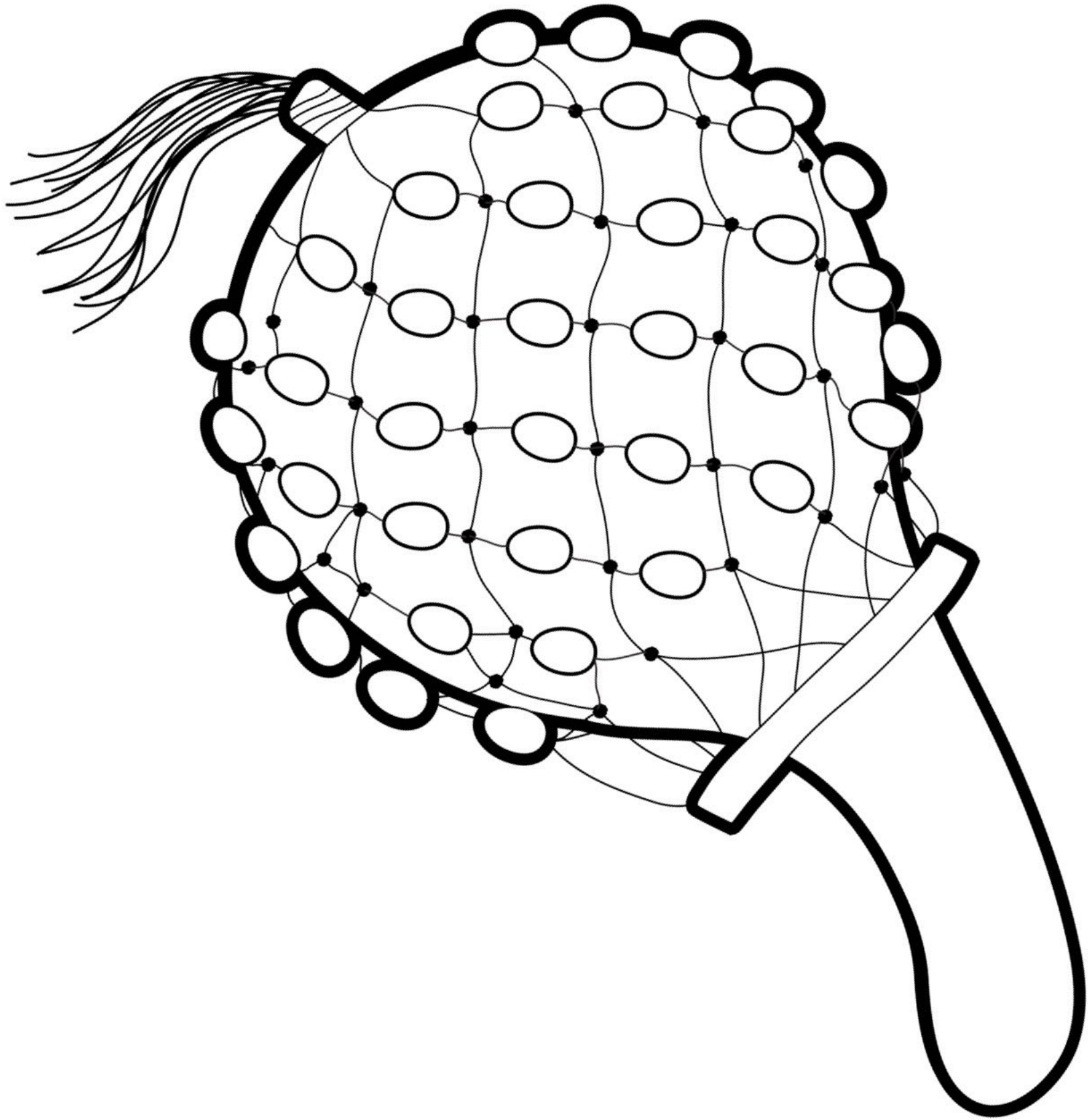

African Shekere

Name _____

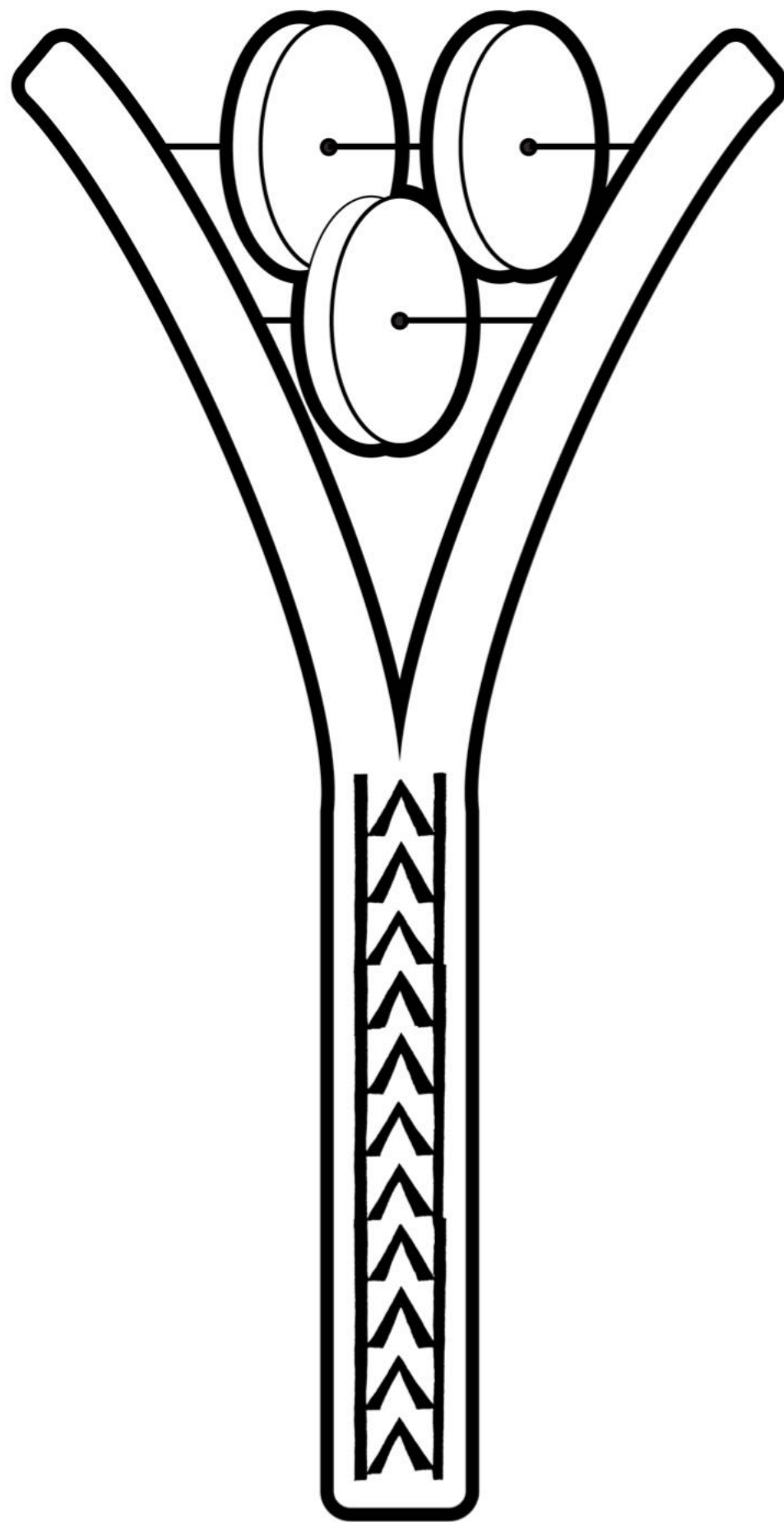

African Sistrum

Name _____

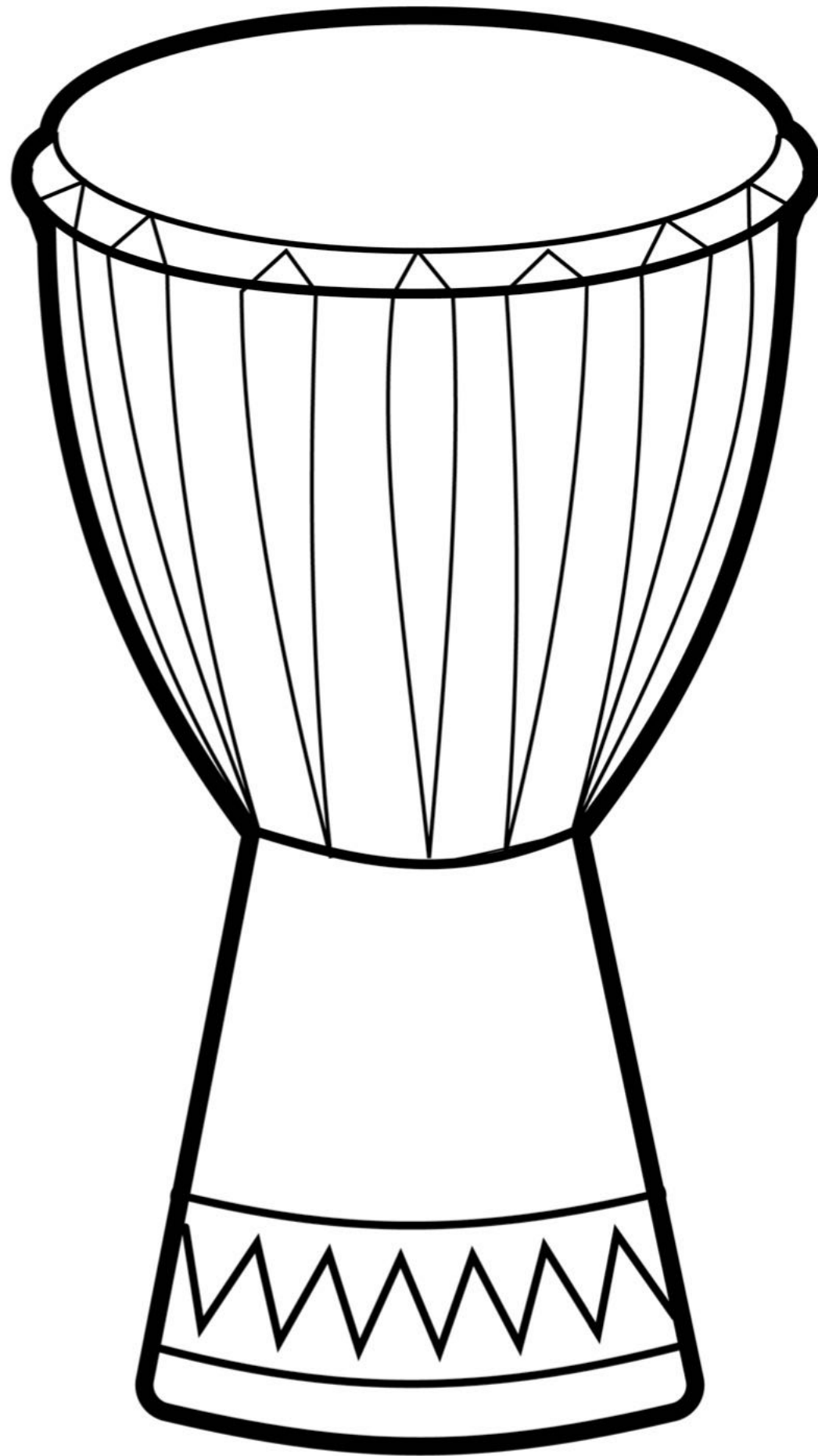

African Djembe

Name _____

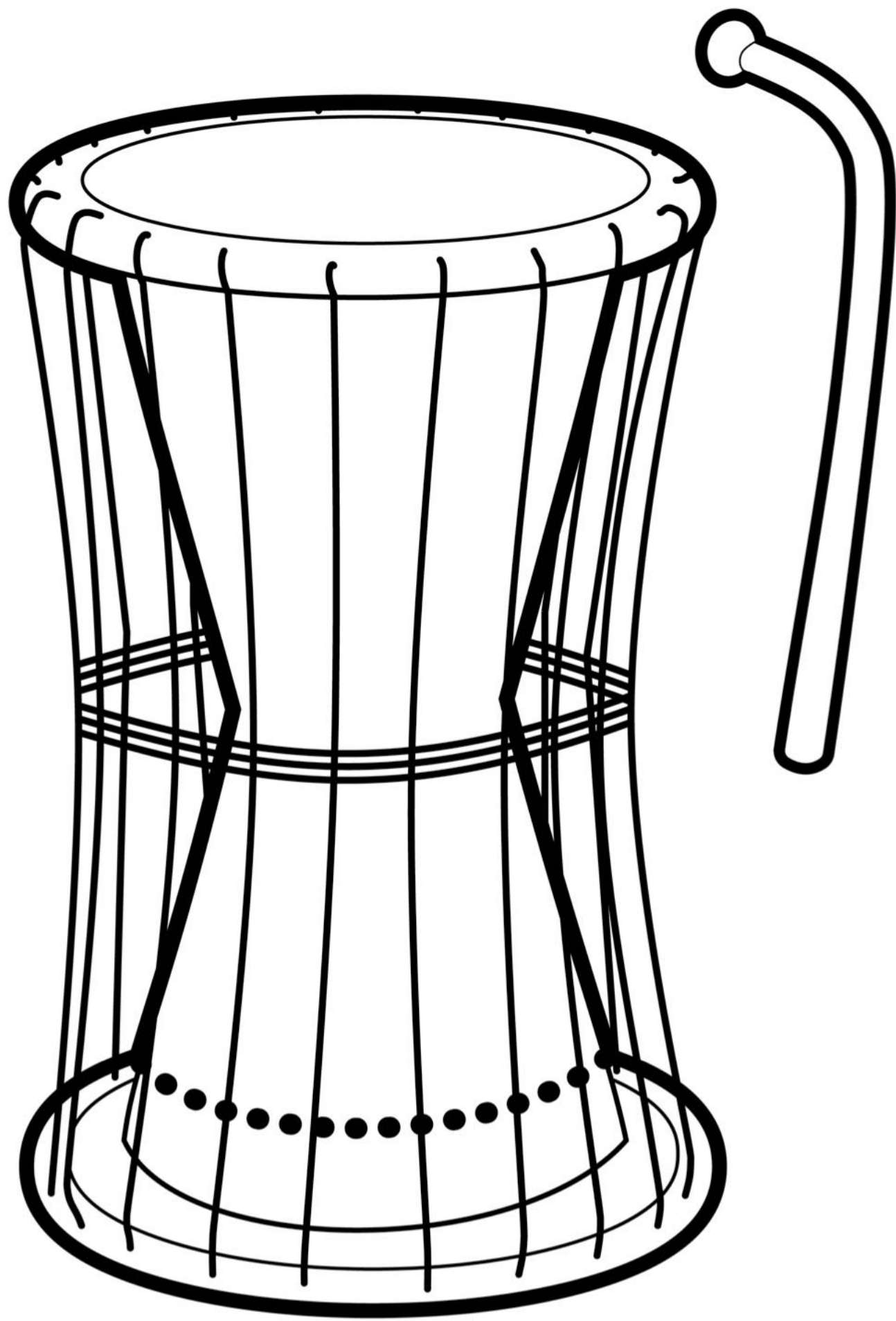

African Talking Drum

Name _____

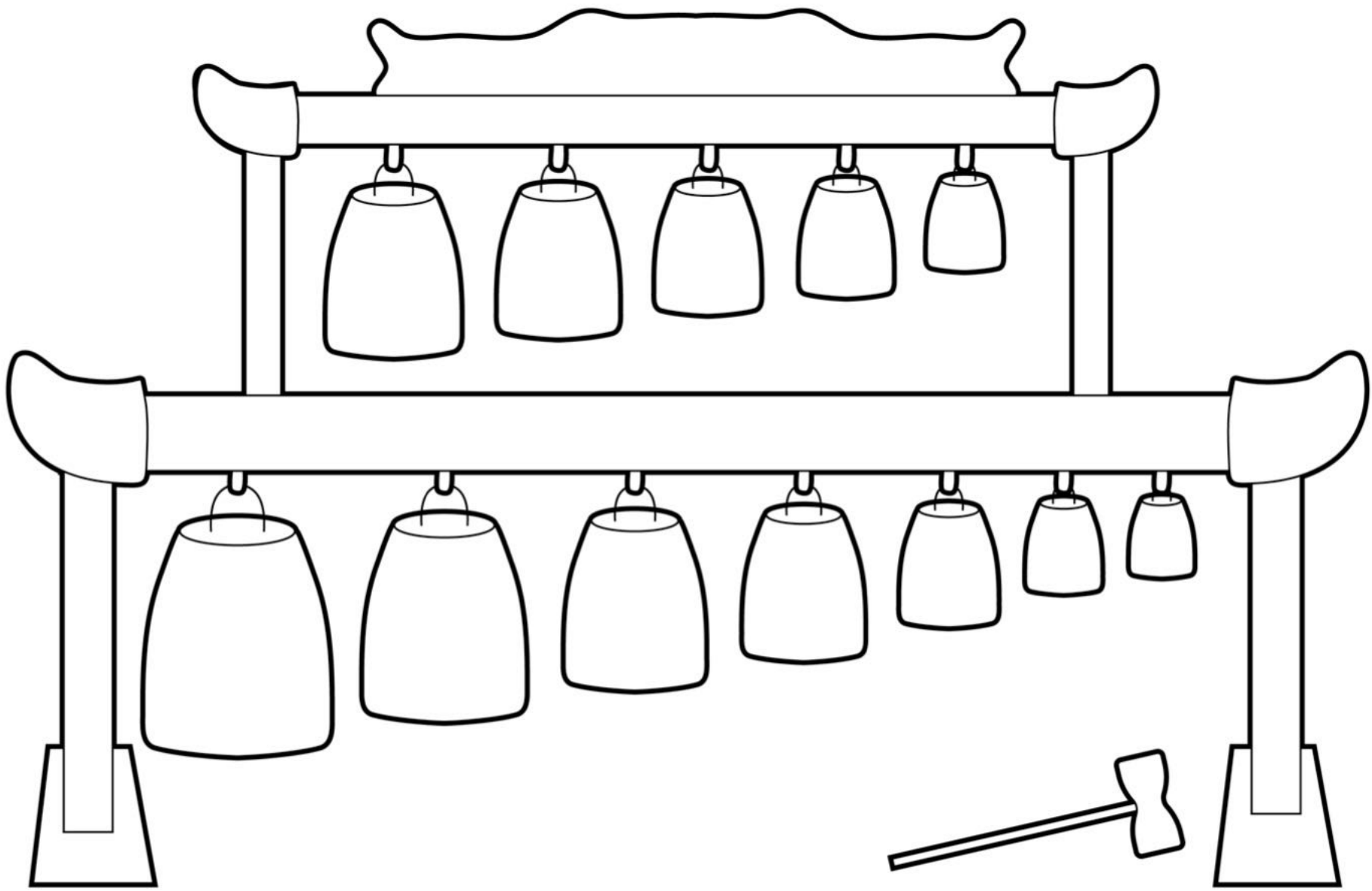

Chinese Bells

Name _____

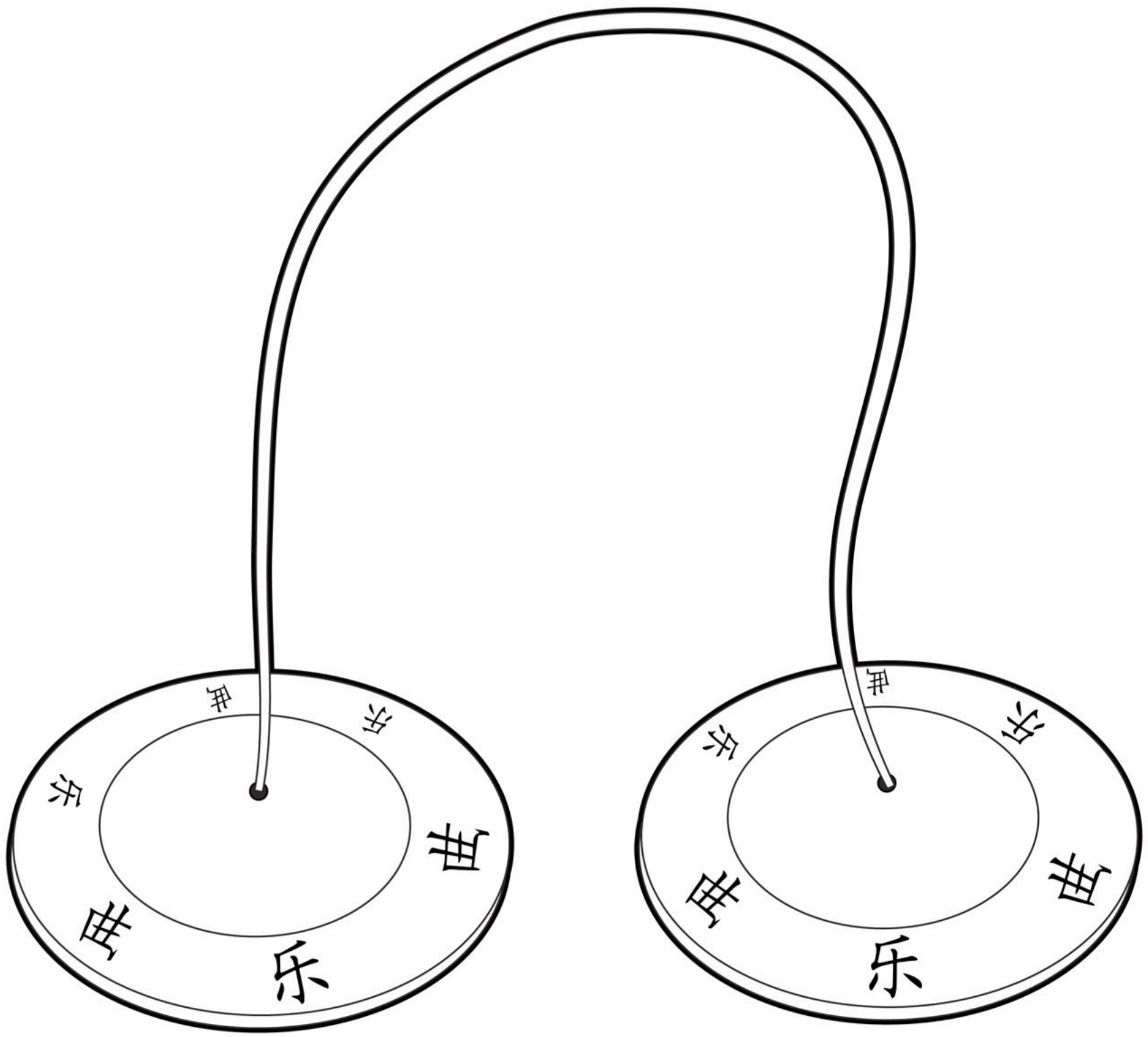

Chinese Gymbals

Name _____

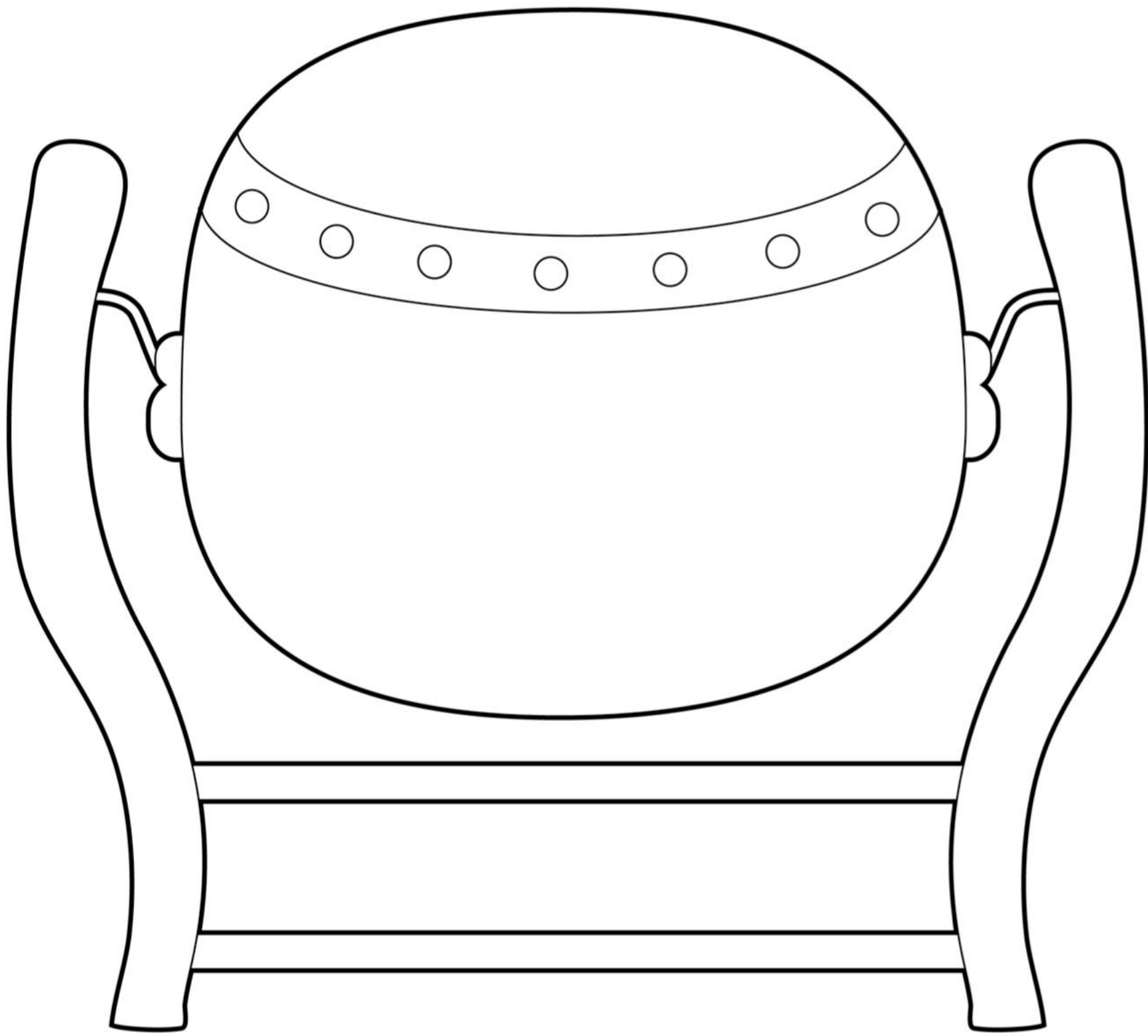

Chinese Drum

Name _____

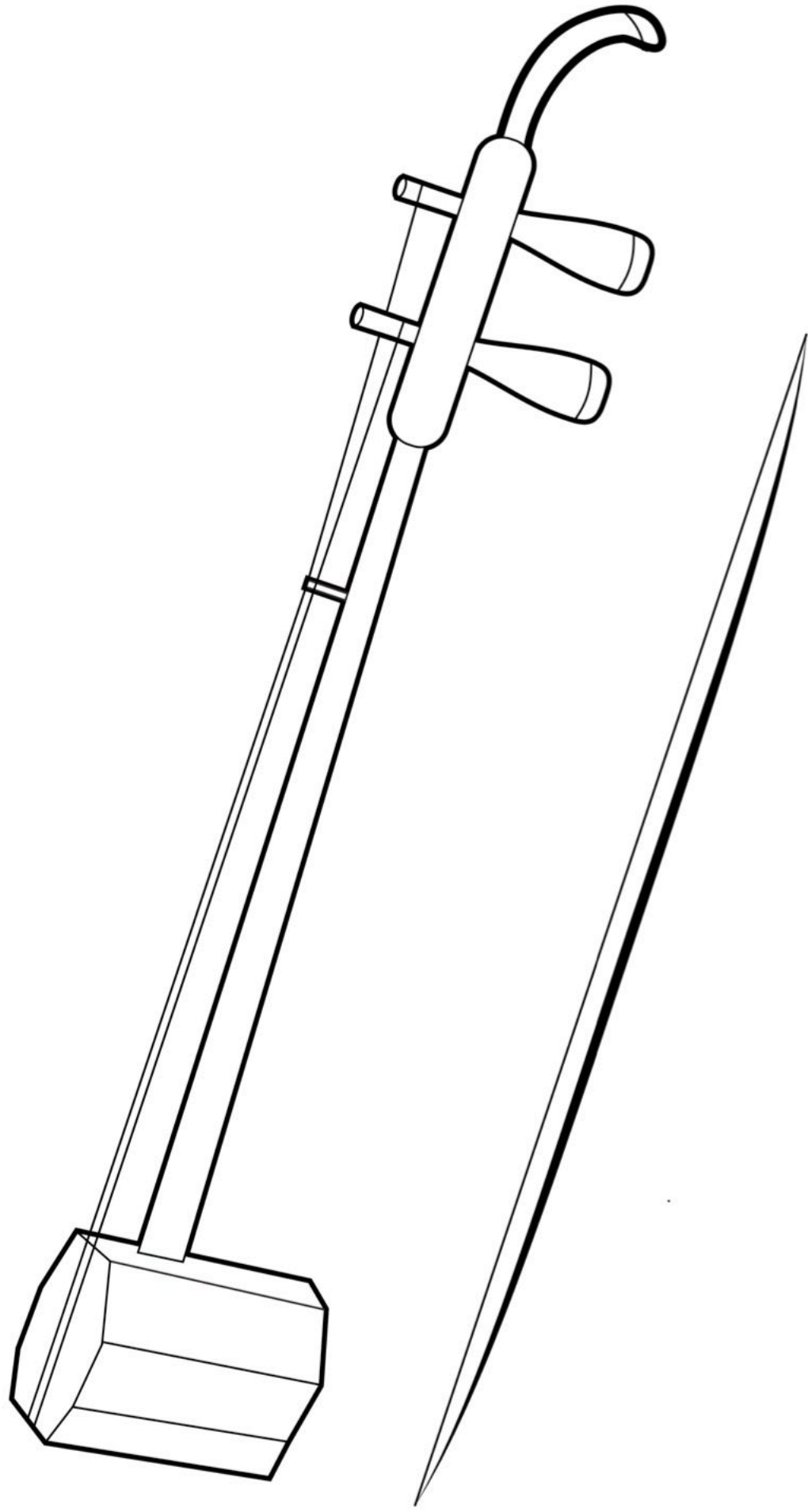

Chinese Erhu

Name _____

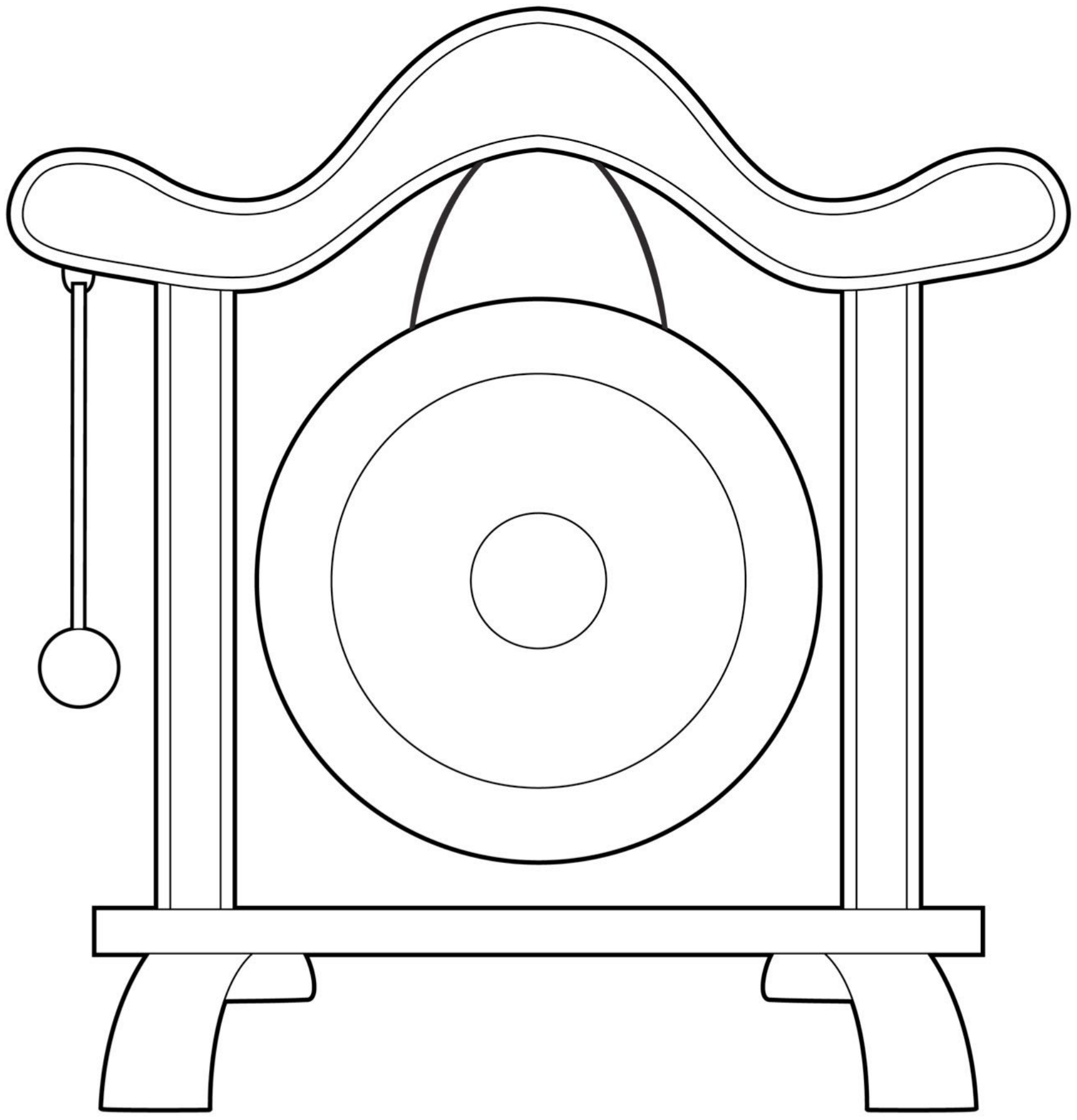

Chinese Gong

Name _____

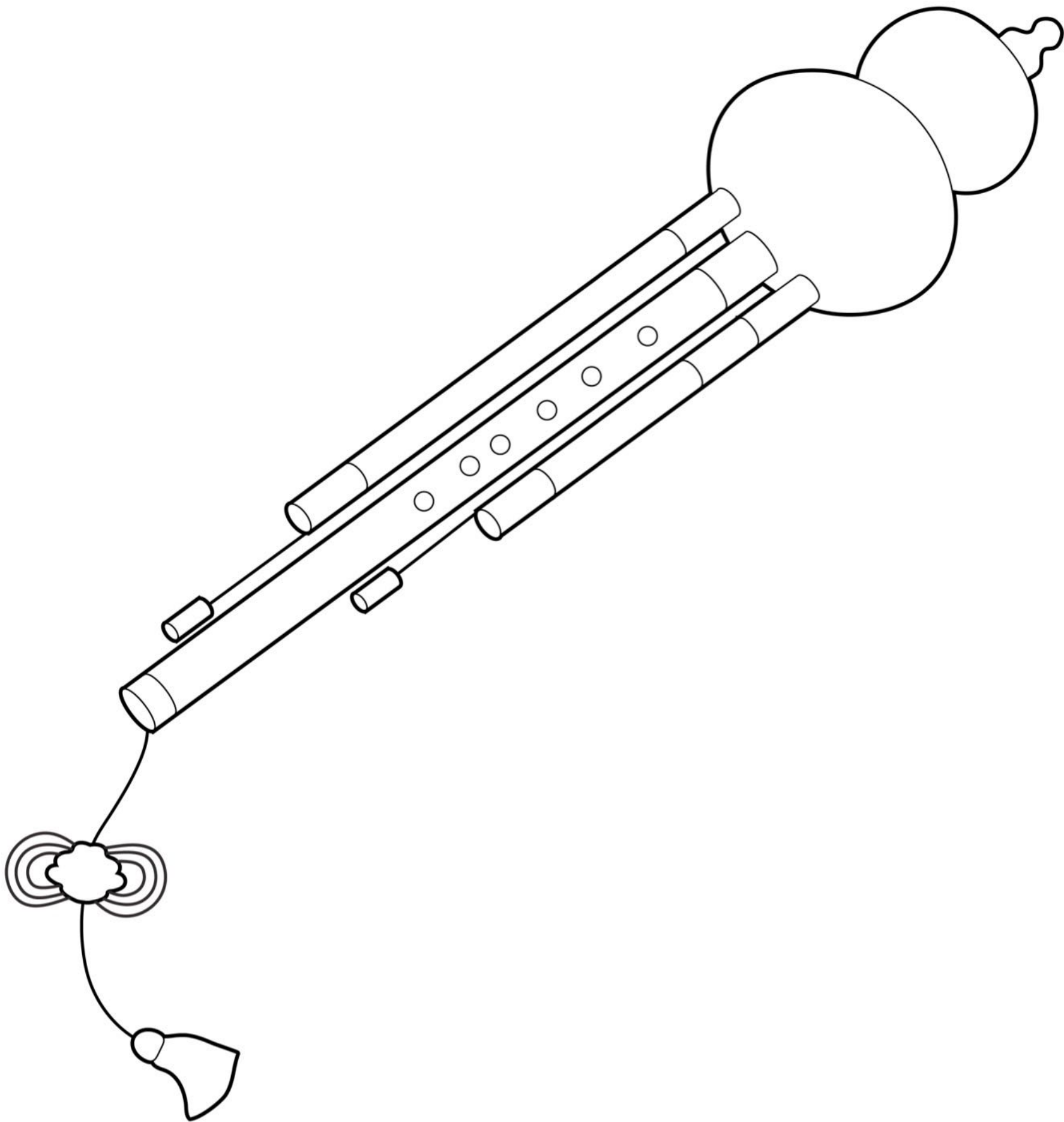

Chinese Hulusi

Name _____

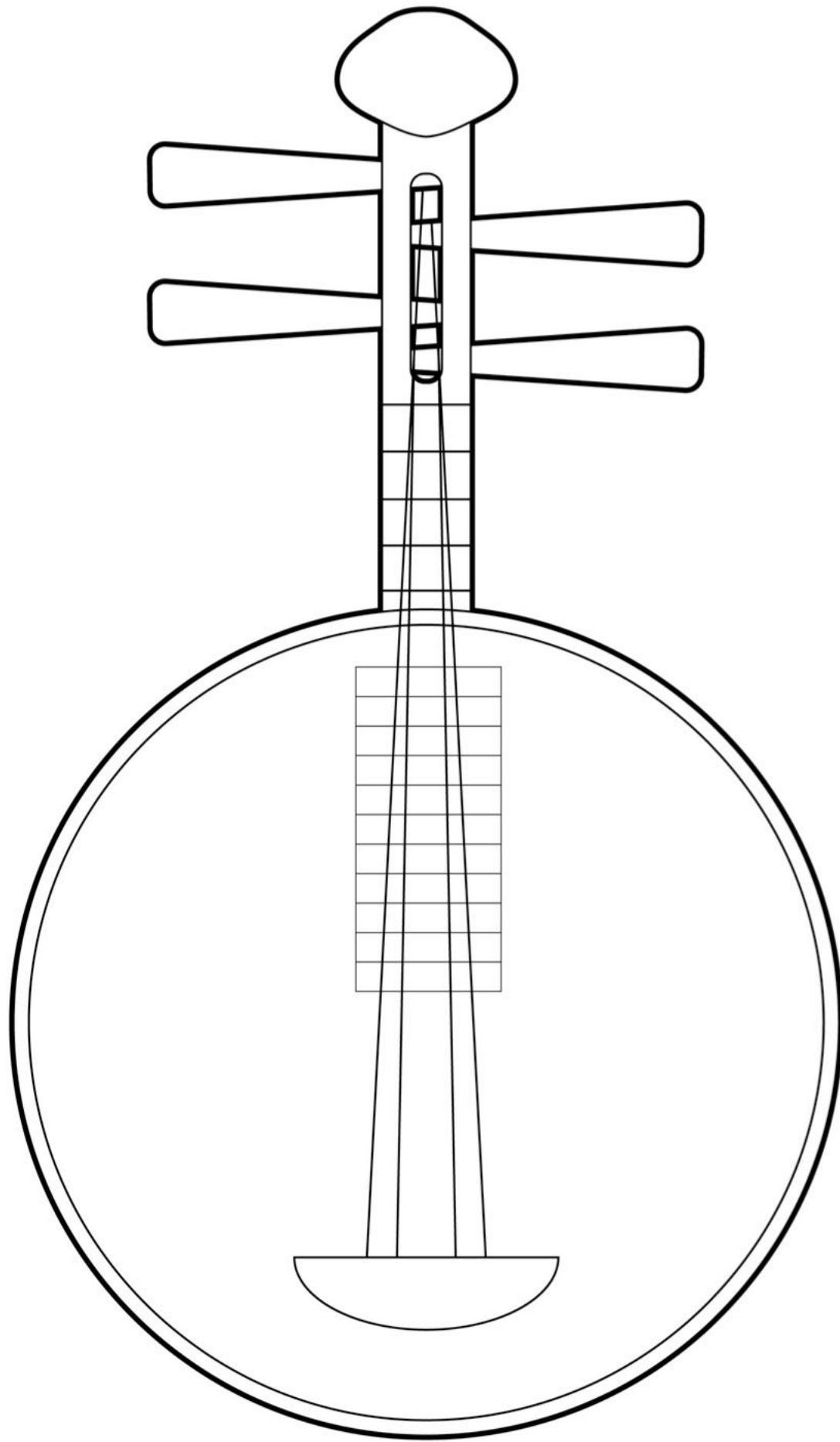

Chinese Yueqin

Name _____

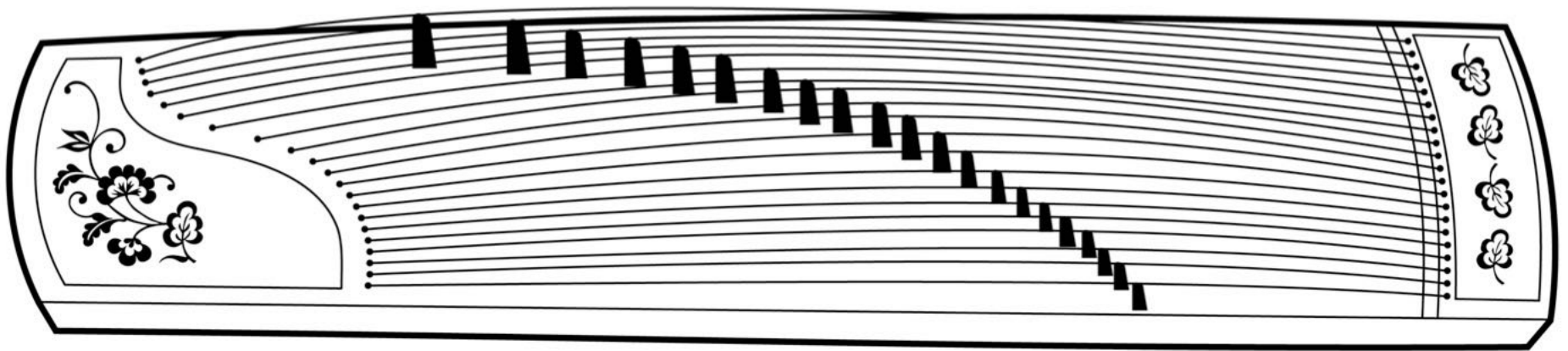

Chinese Guzheng